

# Dynamic Modelling And Control Of Microgrid Renewable Energy Sources

G. Balakrishna<sup>1</sup>, B. Suresh kumar<sup>2</sup>, D. Prasad<sup>3</sup>, G. V. K Murthy<sup>4</sup>, T. Sai kiran<sup>5</sup>

*1PG Student, Dept of EEE, PACE Institute of Technology  
& Sciences, Ongole, AP, India.*

*2,3,5Assistant Professor, Dept of EEE, PACE Institute of Technology  
& Sciences, Ongole, AP, India.*

*4Professor, Dept of EEE, PACE Institute of Technology  
& Sciences, Ongole, AP, India*

## **Abstract-**

*Here in this paper approaches the control of a miniature lattice at a detached area took care of from wind and sun based half breed vitality sources. In this machine utilized for wind vitality transformation is doubly taken care of acceptance generator (DFIG) and a battery bank is associated with a typical DC bus. A sun based photovoltaic (PV) exhibit is utilized to change over sun oriented force, which is emptied at the regular DC transport of DFIG utilizing a DC-DC help converter in a financially savvy way. The voltage and recurrence are controlled through an aberrant vector control of the line side converter, which is fused with hang qualities. It modifies the recurrence set point dependent on the vitality level of the battery, which eases back down over charging or releasing of the battery. The framework is likewise ready to work when wind power source is inaccessible. Both breeze and sun based vitality blocks, have greatest force point following (MPPT) in their control calculation. The framework is intended for complete programmed activity taking thought of the apparent multitude of viable conditions. The framework is likewise given an arrangement of outside force upheld for the battery charging with no extra prerequisite. A reproduction model of framework is created in Matlab condition and recreation results are introduced for different conditions for example unavailability of wind or sunlight based energies, uneven and nonlinear burdens, low condition of charge of the battery. At last a model of the framework is executed utilizing a 5 kW sunlight based PV cluster test system and a 3.7 kW wound rotor acceptance machine and trial results are delivered to reaffirm the hypothetical model and plan.*

## **I. INTRODUCTION**

There are numerous far off areas on the planet, which don't approach power. There are likewise numerous spots, which are associated with the framework, be that as it may, they don't get power for up to 10-12 hours in the day and because of it, financial exercises of occupants endure. Huge numbers of such places are wealthy in sustainable power source (RE) sources, for example, wind, sunlight based and bio-mass. An independent age framework using locally accessible RE source, it can incredibly decrease the reliance on the network power system, it can be prevalently fossil force. The wind along with sun based vitality sources are presents, therefore most loved than bio-mass based framework as last is vulnerable to flexibly chain issues. Be that as it may, wind along sun based energies experience the ill effects of significant level of intensity changeability, low limit usage factor joined with flighty nature in. Because of these variables, firm force can't be ensured for self-governing framework. While the battery vitality stockpiling can be useful of bringing down force change and expanding consistency, usage factor can be expanded by working every vitality source at ideal working points. The ideal working points likewise called as most extreme force point following maximum power point tracking, requires guideline of the working purpose of wind vitality generator and sun powered Photovoltaic exhibit in term of speed and voltage to extricate greatest electrical vitality from input asset. Numerous creators have revealed self-sufficient sun based PV frameworks [1-2] along with self-

ruling breeze vitality frameworks [3-4]. Be that as it may, self-sufficient framework with just one wellspring of vitality requires extremely enormous size of capacity and related PE segments. Wind and sun oriented energies are characteristic partners for hybridizations. Wind and solar have been known to be integral to one another in every day just as yearly example of the conduct. Recognizing preferences of this mix, numerous creators have introduced self-governing solar and wind hybrid energy system in [5-10]. It is conceivable to accomplish gearless design with PMSG, nonetheless, it requires 100% appraised converter notwithstanding costlier machine [11]. In this paper presents a miniature framework took care of from wind and sun based sustainable power source creating sources. The DFIG is utilized for wind power change while translucent sunlight based photovoltaic (PV) boards are utilized to change over sun based vitality. It is proposed a hang based control framework for miniature matrix with the assistance of independent battery converters. In this introduced conspire; the hang trademark is inserted in charge of burden side converter of DFIG system. This capacity changes the framework recurrence dependent on condition of charge of the battery and eases back down profound release and over-charge of the battery Emmanouil et al. [12]. The DFIG in a proposed framework has likewise two voltage source converters. Notwithstanding left side converter, the DFIG likewise has another VSC associated with rotor circuit named as rotor side converter. Then capacity of RSC is to accomplish wind MPPT (W-MPPT). The sunlight based PV framework is associated with the DC transport through sunlight based converter, which helps the sun based PV exhibit voltage system. using this design, the sun based force can be cleared in a financially savvy ways. This approach presents the plan standards of significant segments and control systems for different converter systems. At last it presents reproduction results followed by exploratory outcomes acquired on a model created in the lab.

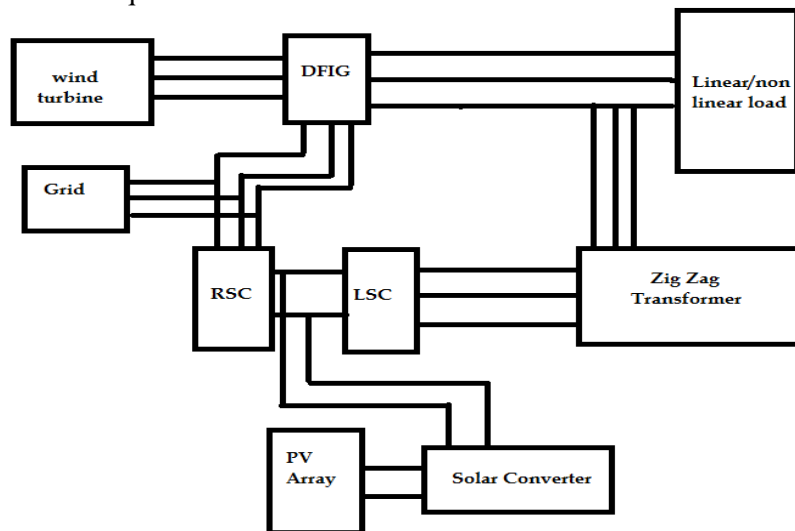

Fig. 1 Renewable energy sources is connected to linear/non linear load

## II. DESIGN OF SYSTEM COMPONENTS

A solitary line chart of the proposed sustainable power source age framework proposed took care of miniature network is Fig. 1.shows in. The equivalent has been intended for area having greatest force request and normal force request of 15 kW and 5 kW, individually. The appraised limit of both breeze and sun based vitality block in REGS, is taken as 15 kW. The limit usage factor of 20% is considered for both vitality blocks, which is sufficient to give entire day vitality necessity of the villa.

Separated utilizing a 3-post breaker from the organization if there should arise an occurrence of inadequate breeze speeds. Then DC side of both RSC along with LSC alongside HV side of sunlight based converters, is associated at the battery bank. RSC helps the breeze vitality framework to run at the ideal turn speed as required by W-MPPT calculation. The LSC controls the organization voltage and recurrence. The vitality stream outline of the framework is appeared in Fig. 2.

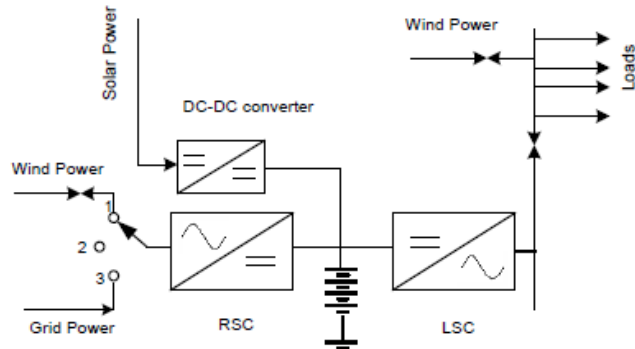

Fig. 2 Energy management diagram for proposed microgrid

**III. MICROGRID CONTROL STRATEGY**

As appeared in Fig.1, Renewable energy source generation comprises of three converters, which control portrayals, are given as follows. A sun oriented converters, which is a lift type DC-DC converters used to clear sunlight based force with installed S-MPPT rationale. It depends on gradual conductance strategy [16]. The S-MPPT through savvy exchanging directs us so as the close planetary system works at MPP. The stream graph of the MPPT calculation is appeared in Fig.3. The inland wind turbine creates power just for 50-60% about the time in; the framework ought to be intended to work when no wind power is accessible. It can appear in the control chart in Fig. 4,  $i_{qs}$  comprises of two segments. The principal part,  $i_{qs1}$  relates to the force segment of DFIG currents, then wind turbine is in activity. Then second parts  $i_{qs}$  relates to the force segment drawn when stator of DFIG isn't associated with the heap terminal.

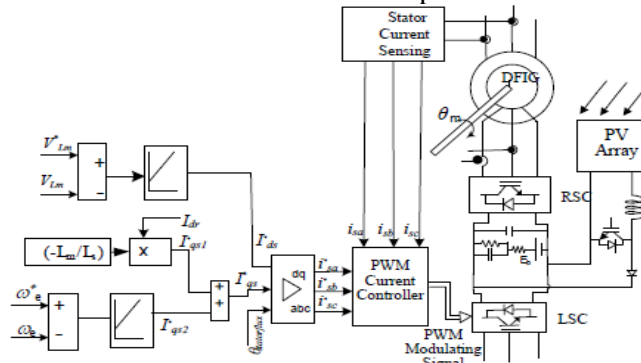

Fig. 3 control diagram of microgrid

**IV. SIMULATION RESULTS**

Microgrid Using RES simulated in Matlab is shown in figure.4 Here it can observe wind turbine and solar panels are developed by their particular characteristics by the respected equations. In the simulation results can see different types of cases are considered, the first case is without wind generator, remain system performance is shown in figure 5. The second case is without solar panels, remain system performance is shown in figure 4. Here the both cases are considered in the MPPT is presents in the system. The next case is load is sudden disconnected to the system is shown in figure 6, and the next case is un balanced system considered is shown in figure 7, next case is when put away vitality and created power are low and outer charging prerequisite through RSC is enacted is shown in Fig. 8, and the final case when DC bus voltage is running at high charging power is shown in Fig.9.

**Case 1-- Wind fluctuations with constant load condition**

The system is 10kW along 6 KVAR load, in this case up to time at  $t=2.25s$  without solar is considered, up to  $t=2.25s$  wind speed is taken 7m/s. and after some time wind speed varies from 7m/s to 8m/s and then wind power is correspondingly increases but bus voltage remains same

shown in fig , after 10s the wind speed decreases to 8m/s to 7m / s in this situation also the wind power is decreased there is no change in bus voltage is shown in figure.4

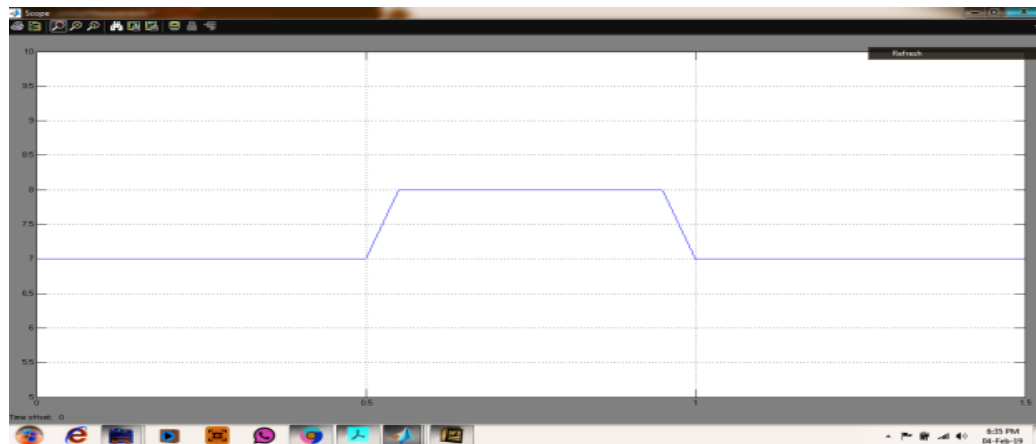

Fig.4(a)

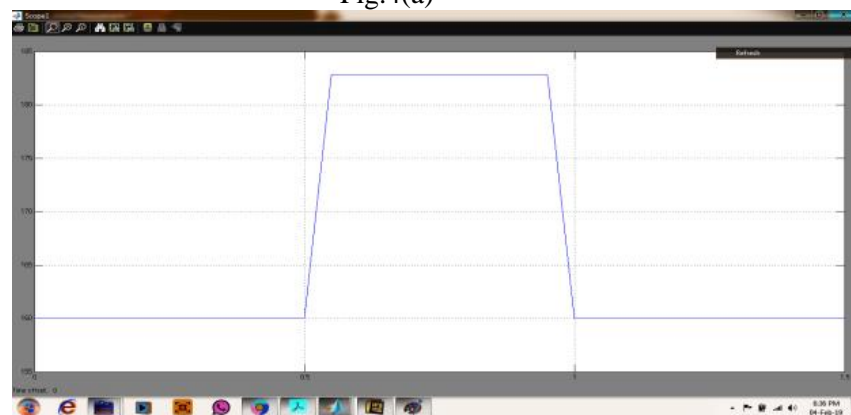

Fig.4(b)

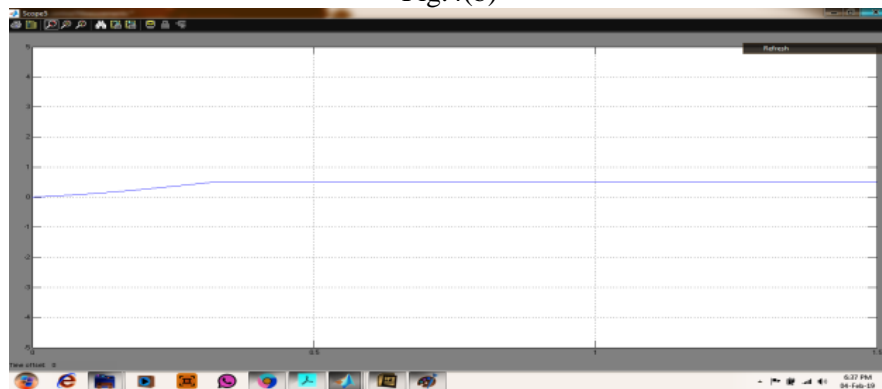

Fig.4(c)

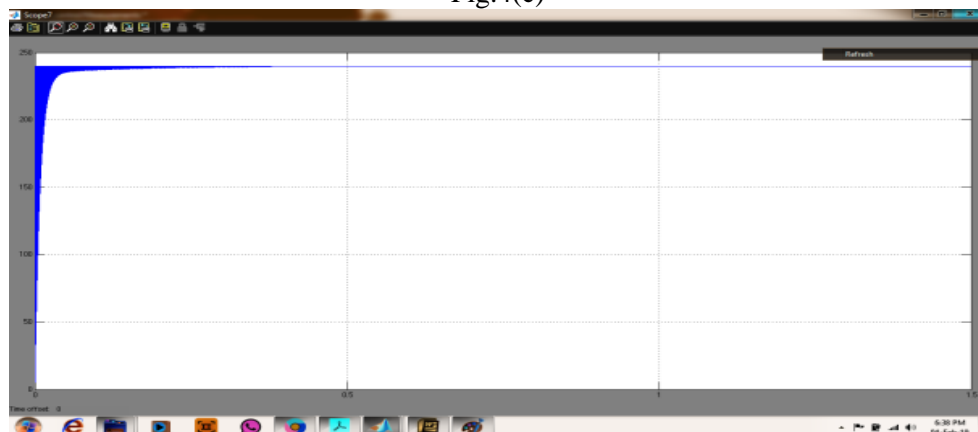

Fig.4(d)

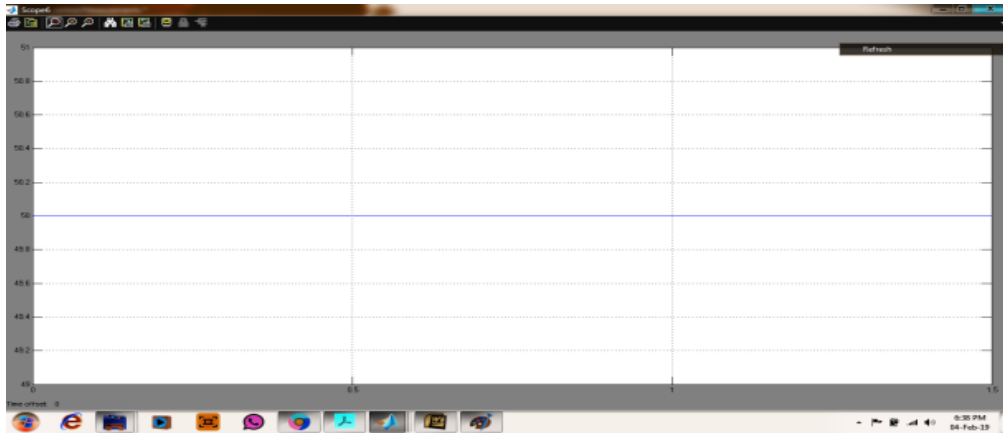

Fig.4(e)

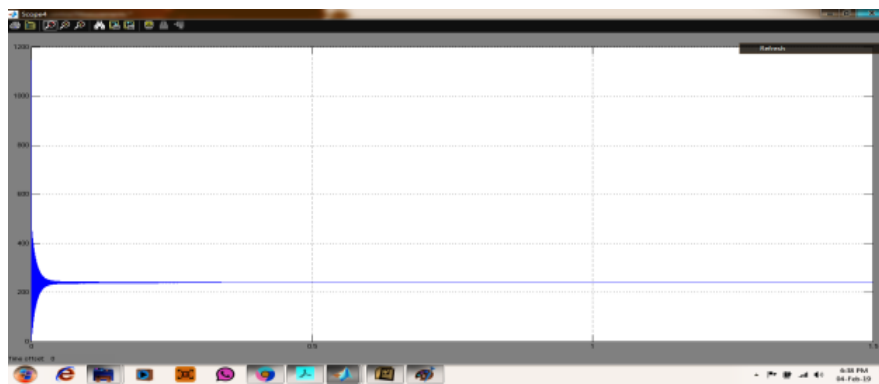

Fig.4(f)

Fig.4. wind without connection

**Case 2-- solar irradiation fluctuations with continuous load**

Fig. 5 illustrates that at time  $t=2.5$  s, the input of solar irradiations is  $750 \text{ W/m}^2$ . The radiation of solar is raised to  $900 \text{ W/m}^2$  at time  $t=4$ s, changing of solar radiation again to  $800 \text{ W/m}^2$  at  $t=6.5$  s. In this cases the converter of solar inverter operating at maximum power point tracking conditions. The solar system is taking out of service at  $t=7.5$ s. the voltage is variation is no change on common bus at any point.

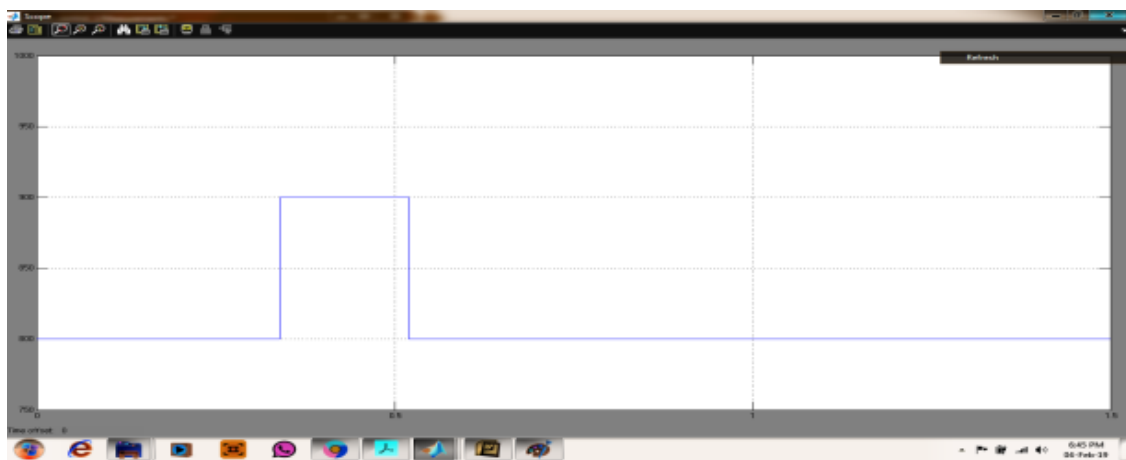

Fig.5(a)

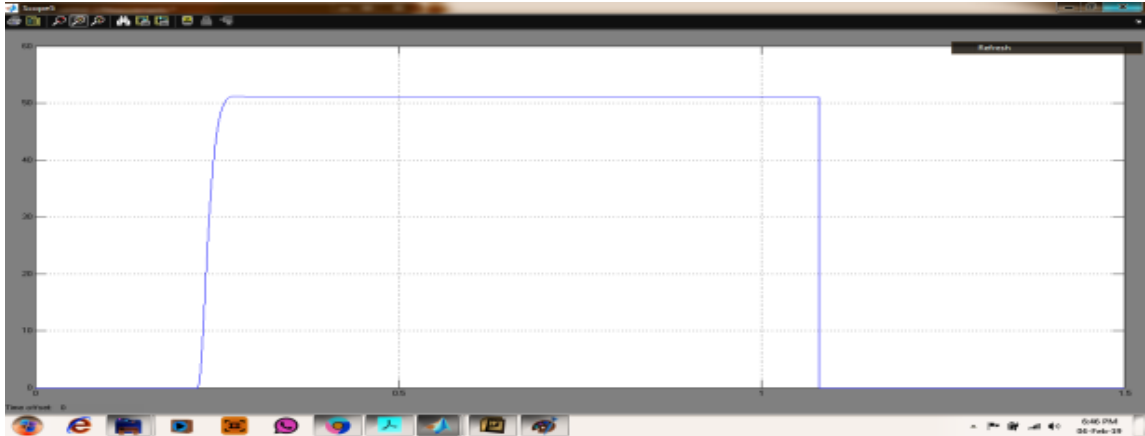

Fig.5(b)

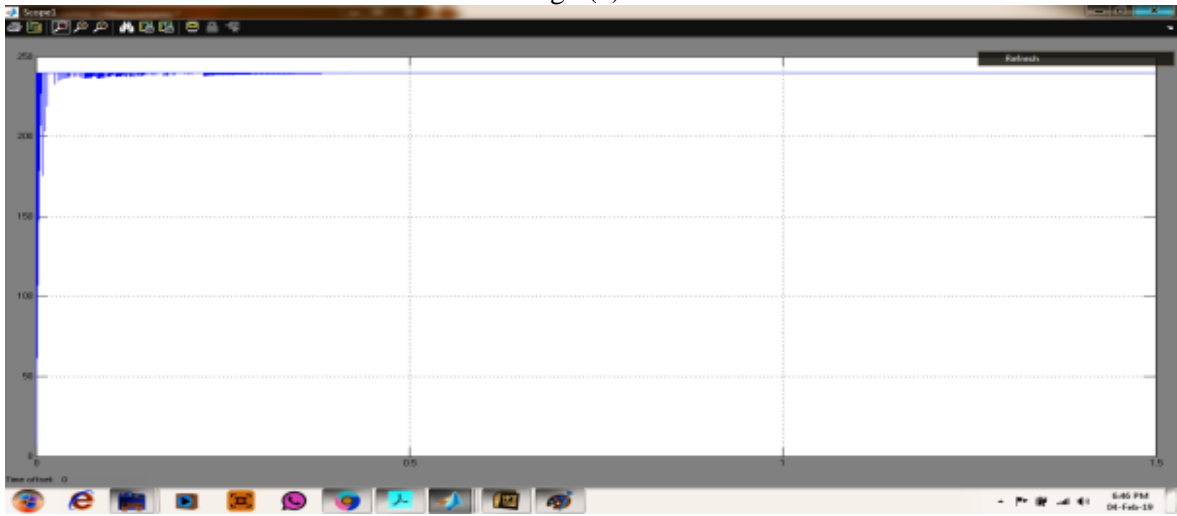

Fig.5(c)

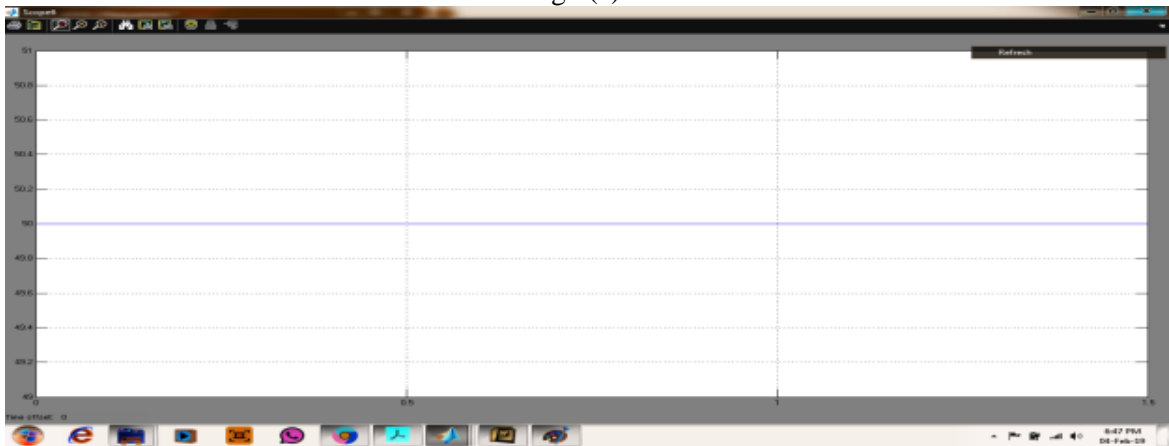

Fig.5 (d)

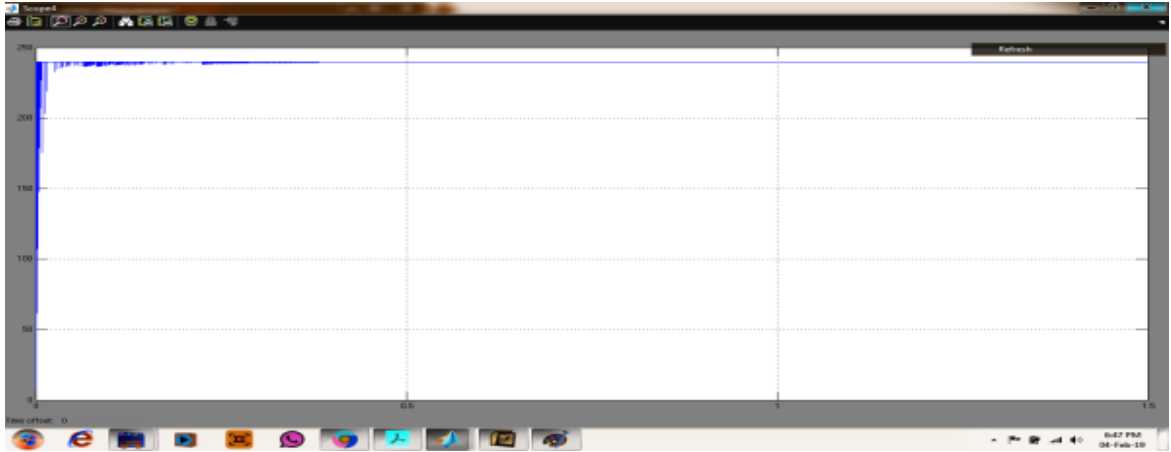

Fig.5(e)

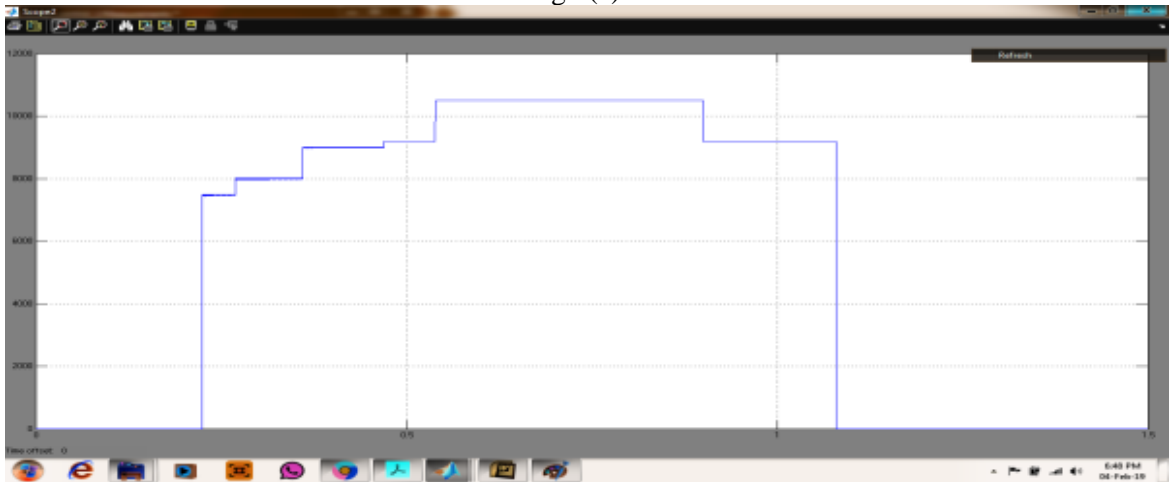

Fig.5(f)

Fig.5. Solar without connection

**Case-3-- When system is connected to un balanced load**

Case 3 illustrates those non linear unbalanced loads performances shows in fig.6. This proposed system is convenient to unbalanced and balanced loads in nonlinear. The last case is no generation is not possible in produce the power from generators. Total load is connected to system is 8 kW non linear load and 2 kW linear load. The r phase load is suddenly omitted from at 3.2s, along with y phase is at t= 3.4s, this can be observe the proposed microgrid continually supplying different loads and various situations also.

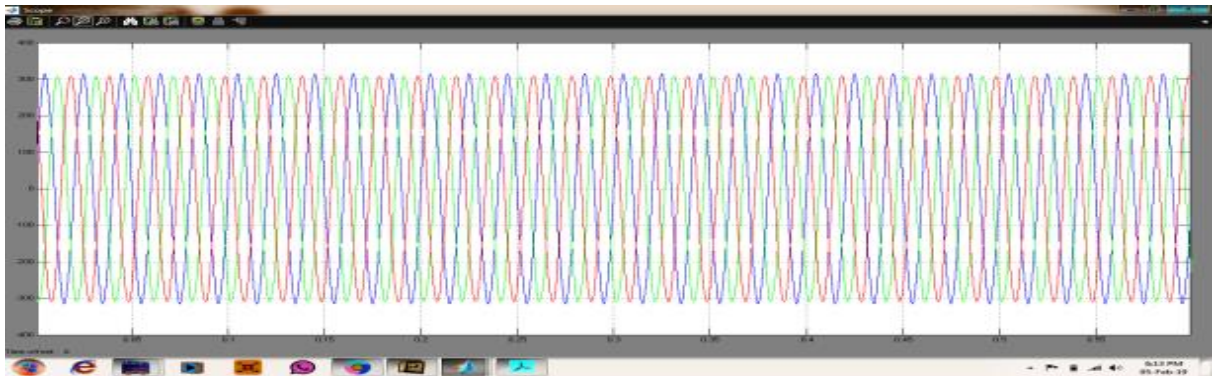

Fig.6(a)

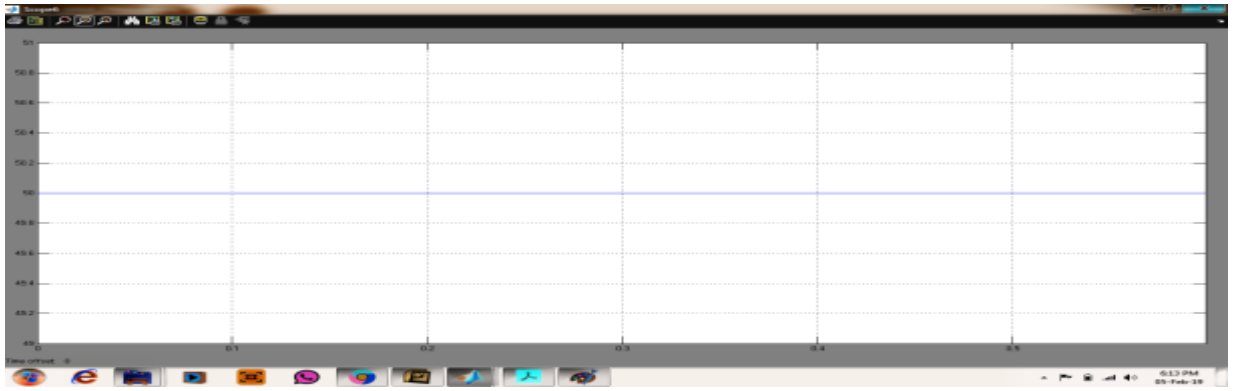

Fig.6(b)

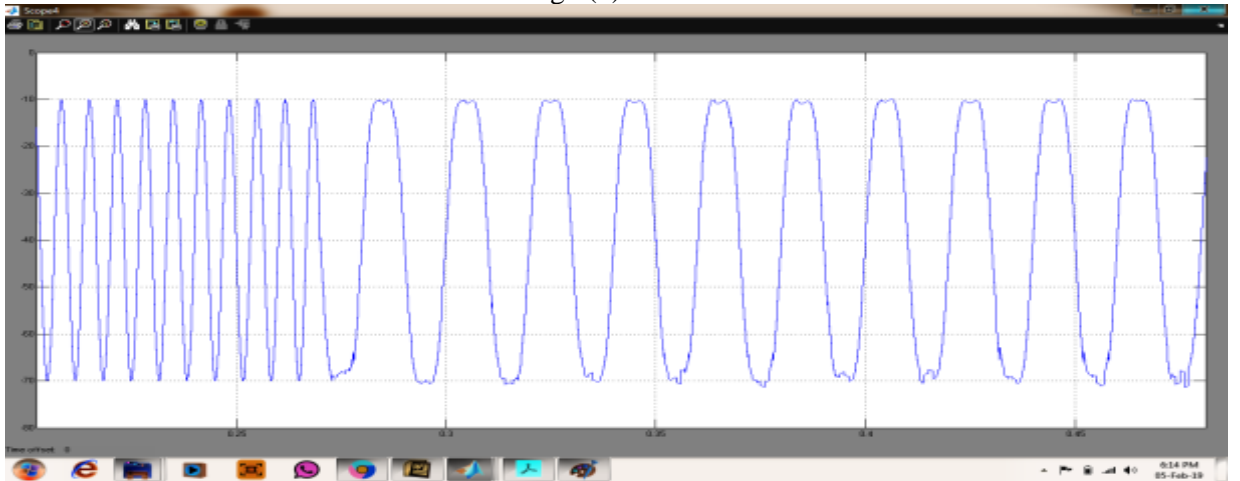

Fig.6(c)

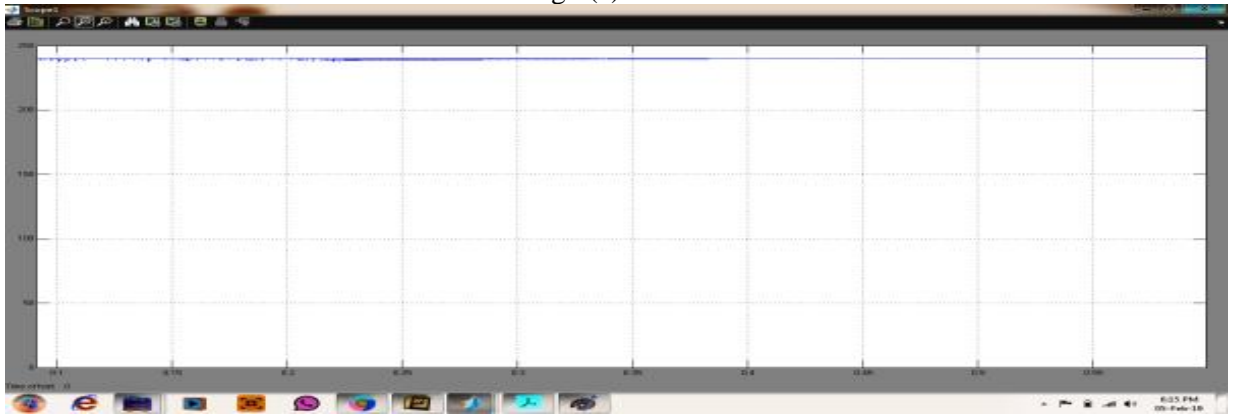

Fig.6(d)

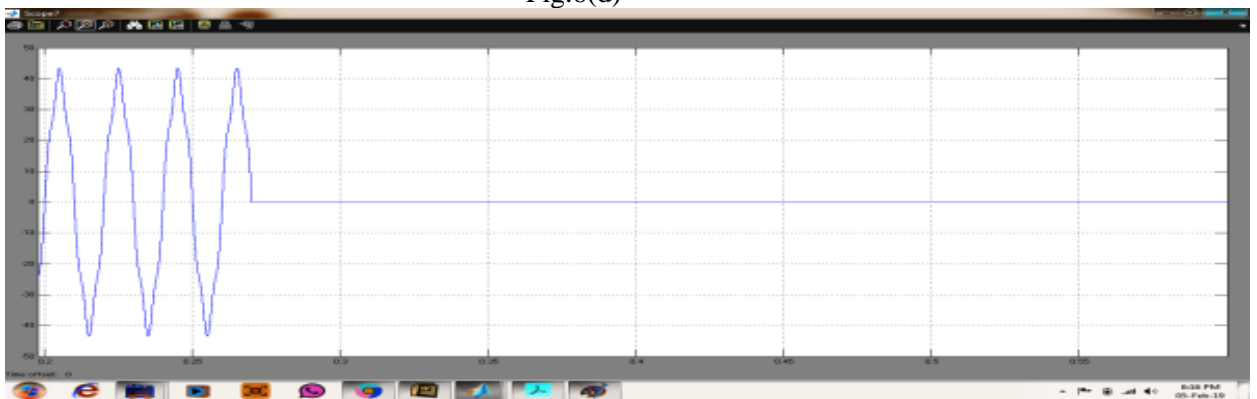

Fig.6(e)



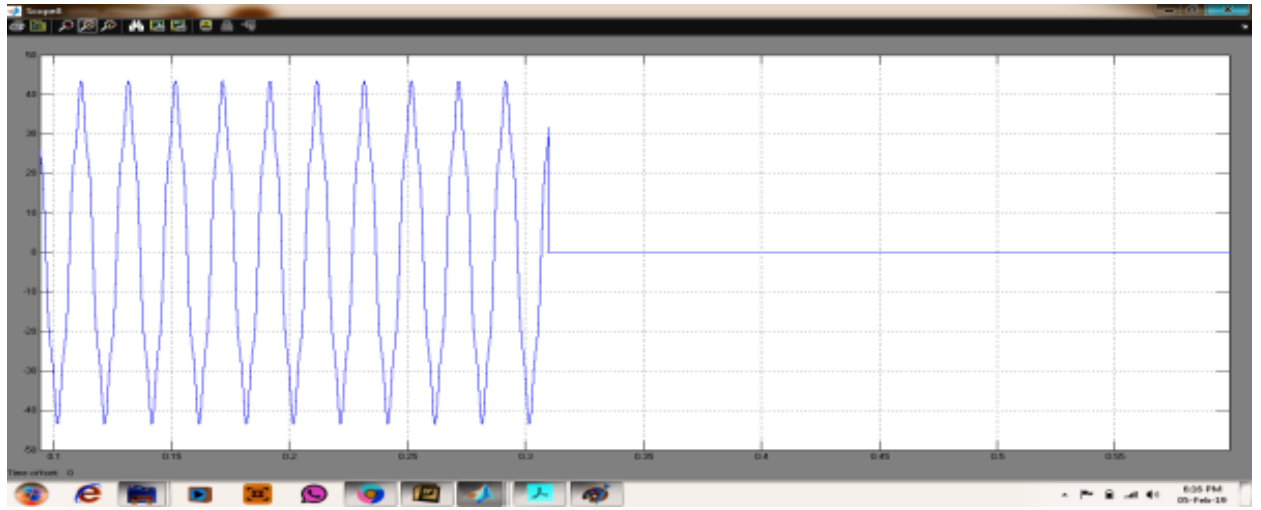

Fig.6(f)

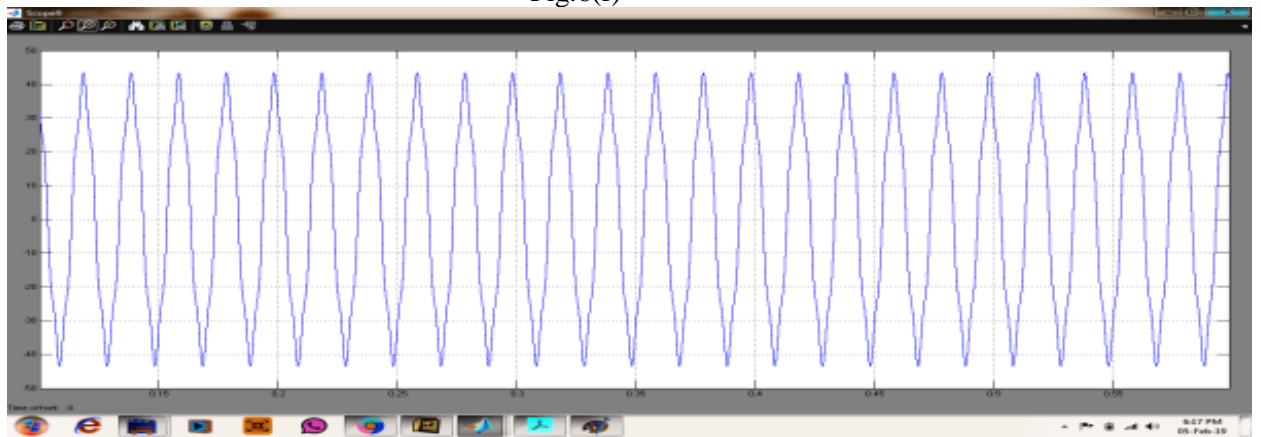

Fig.6(g)

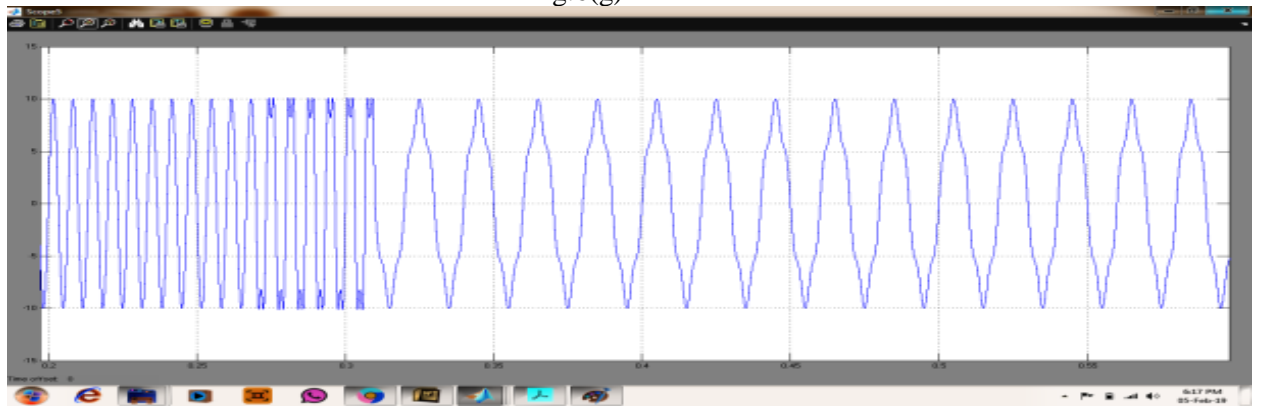

Fig.6(h)

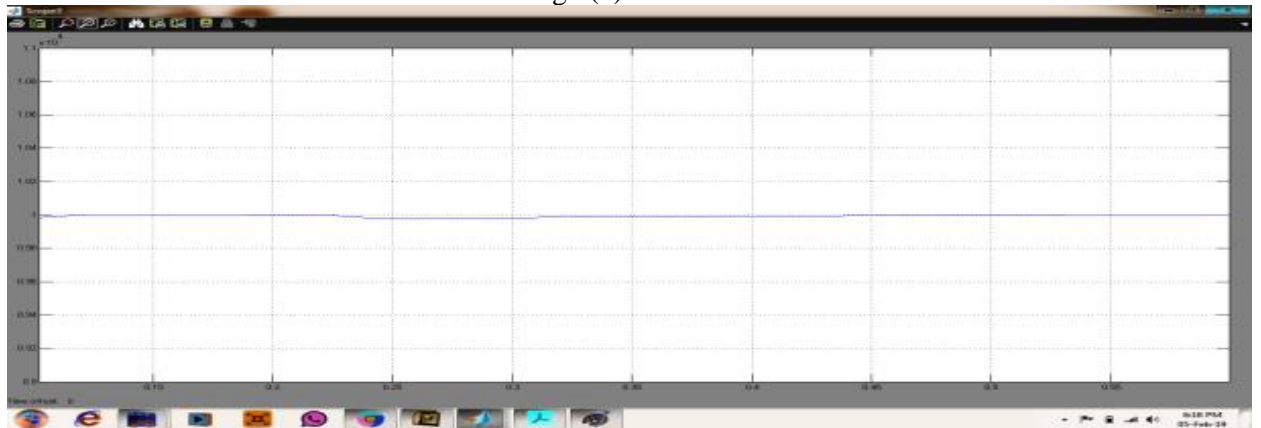

Fig.6(i)  
Fig.6. When balanced load connects

**Case-4-- When the load is disconnected**

During loss load conditions, the load is disconnected to supply. In this case the wind generation and solar power is supplies the battery is shown in fig.7. The load omitted at  $t= 2s$  then the frequency and voltage constant and stable in this conditions.

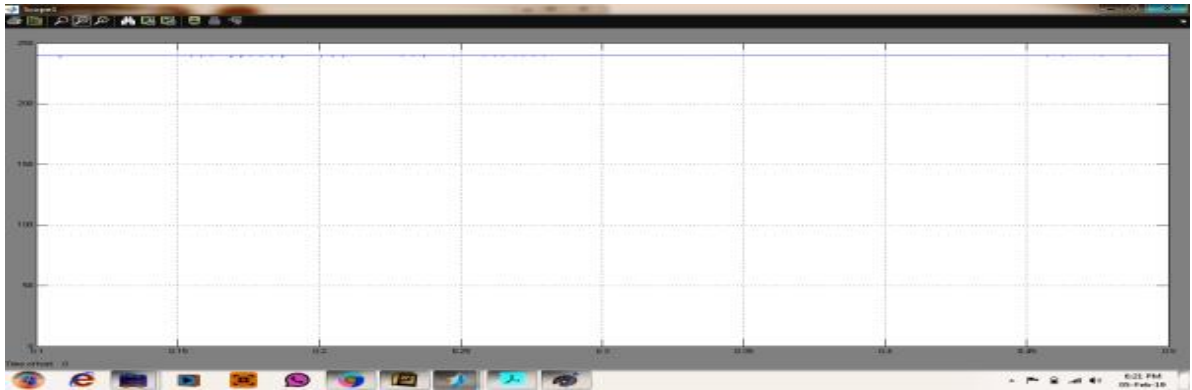

Fig.7(a)

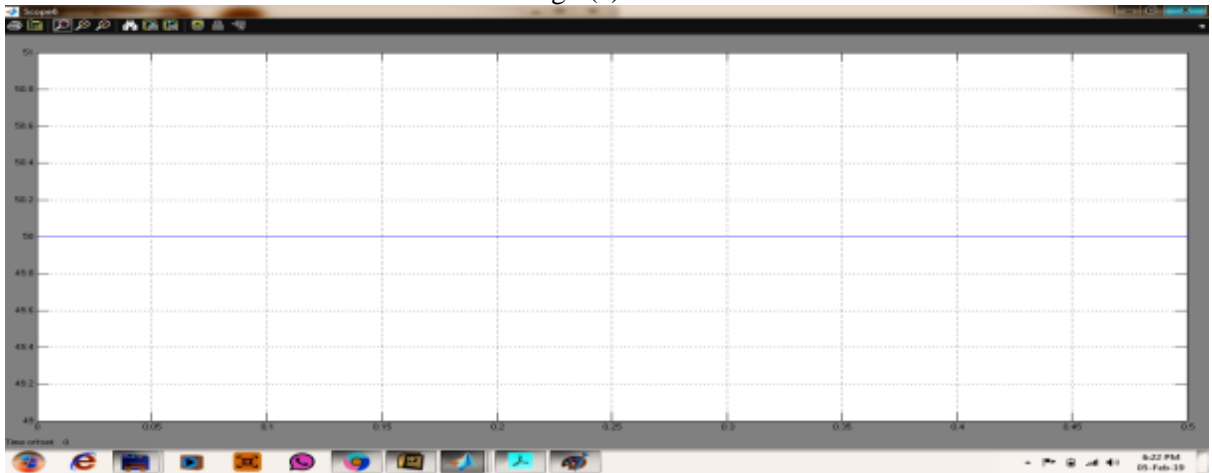

Fig.7(b)

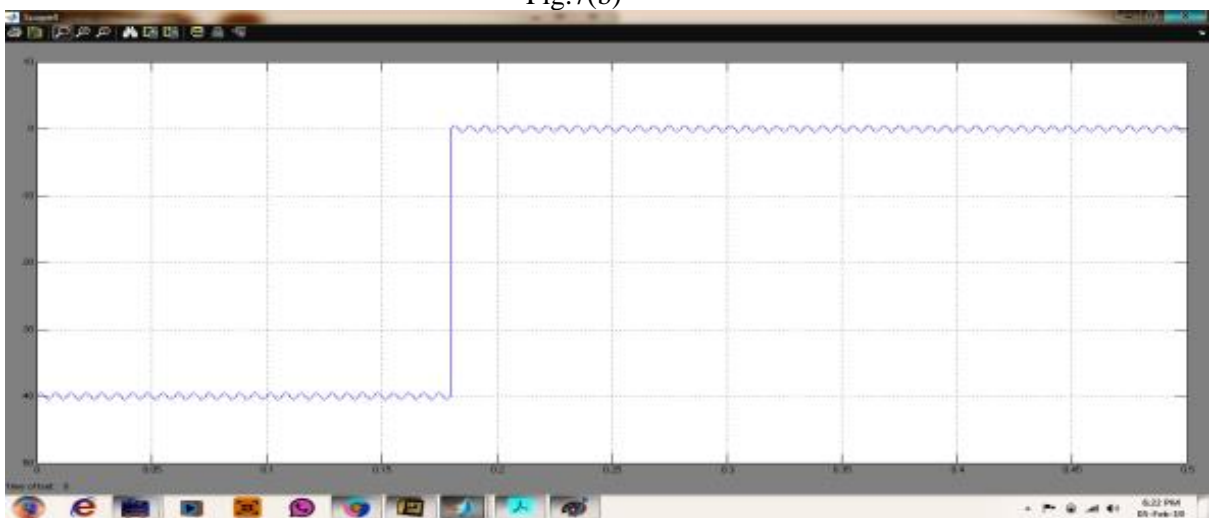

Fig.7(c)

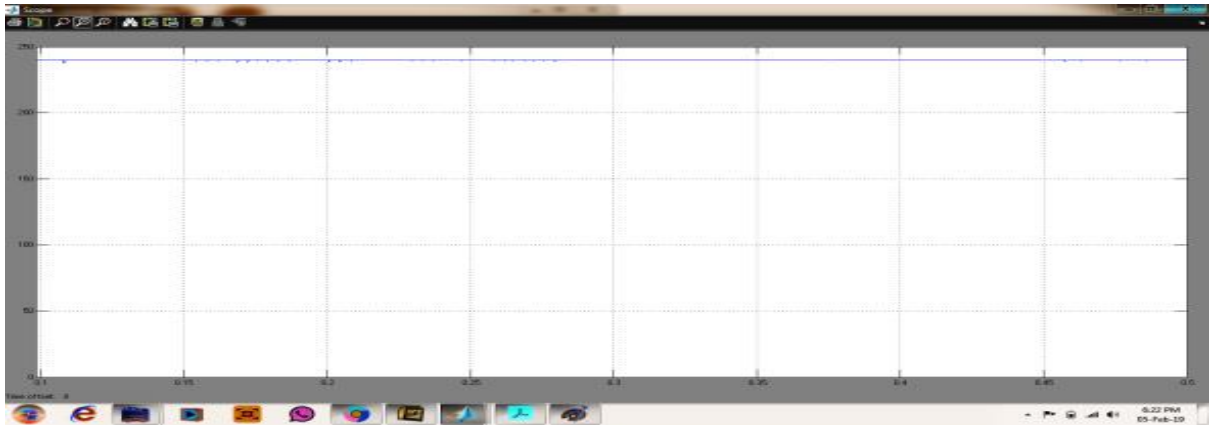

Fig.7(d)

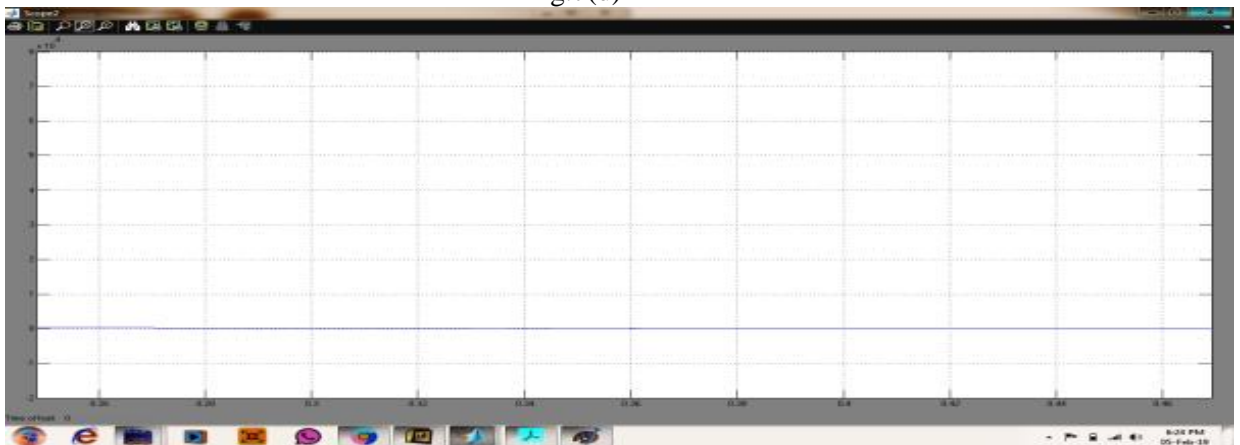

Fig.7(e)

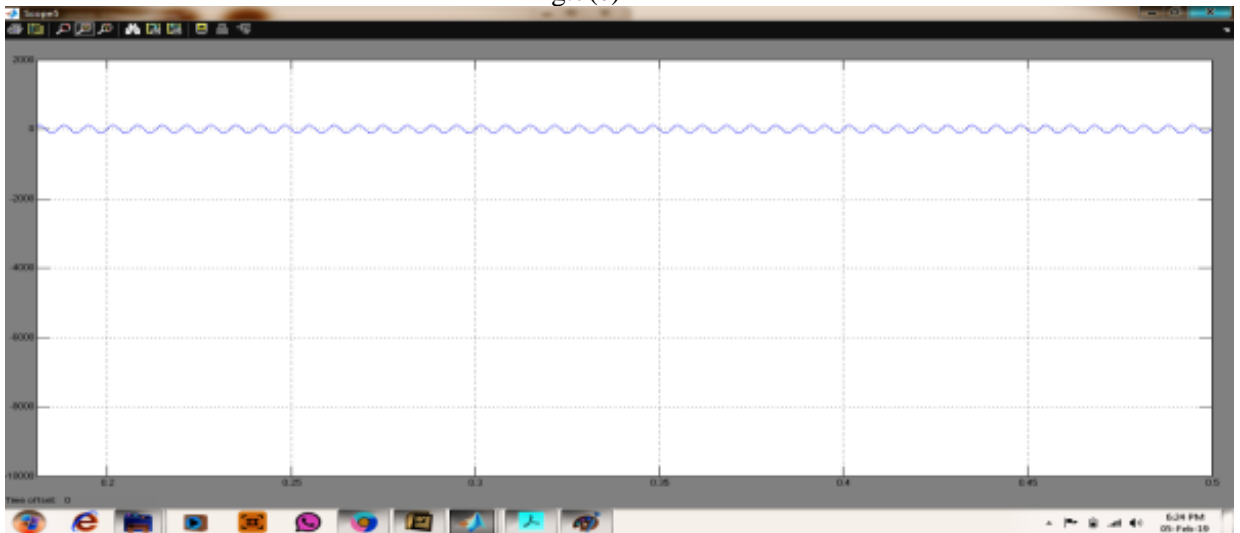

Fig.7(f)

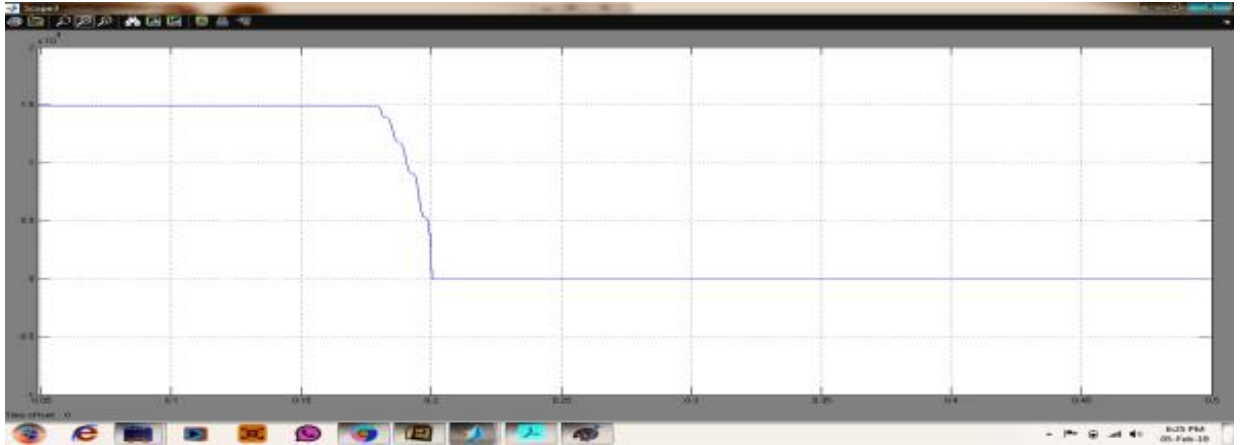

Fig.7(g)

Fig.7.Renwable energy sources without generation charging of battery

**Case-5--Renewable energy sources without generation charging of battery**

In this case of worst scenario explains, there is no generation from generators along with the there is no charge in batteries. Then in this worst case also can provide extra power supply in this proposal system. Here at  $t=4s$  illustrates that there is no power produce and low battery state, the circuit is changes to external power source charge the batteries trough the RSC converter system is shown in fig.8.

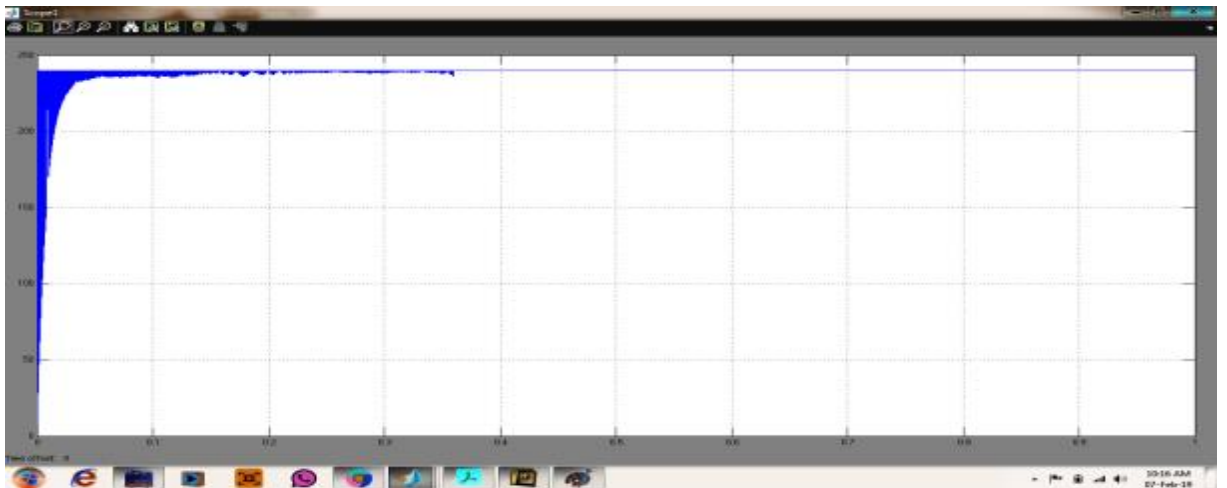

Fig.8(a)

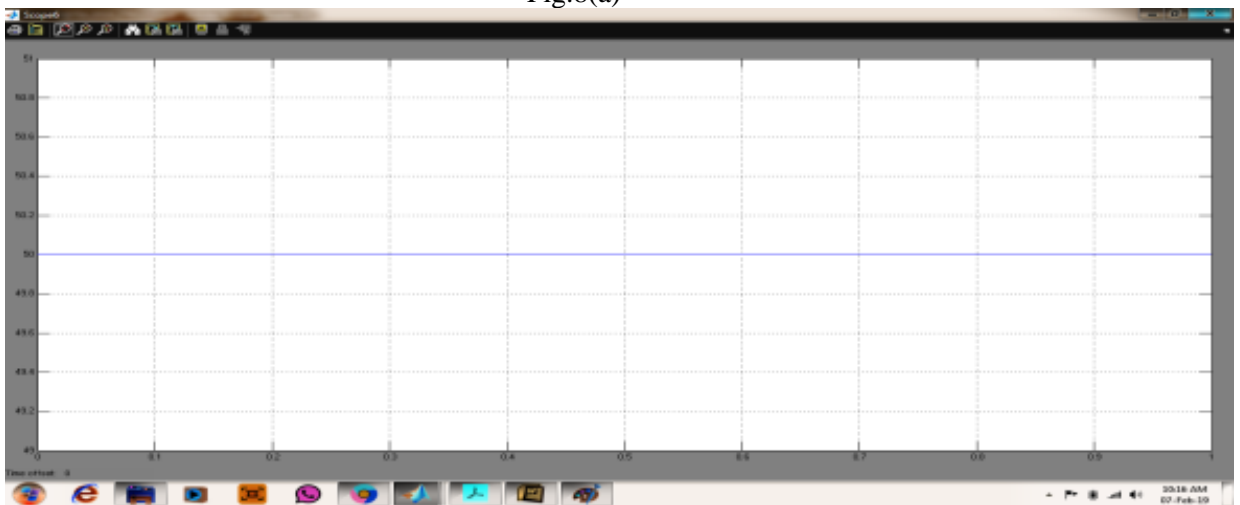

Fig.8 (b)

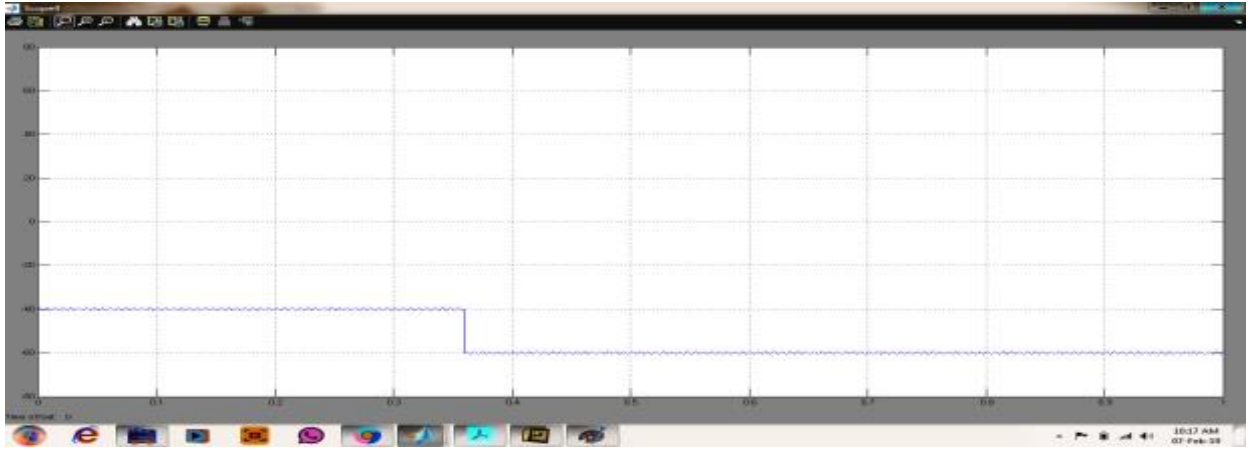

Fig.8(c)

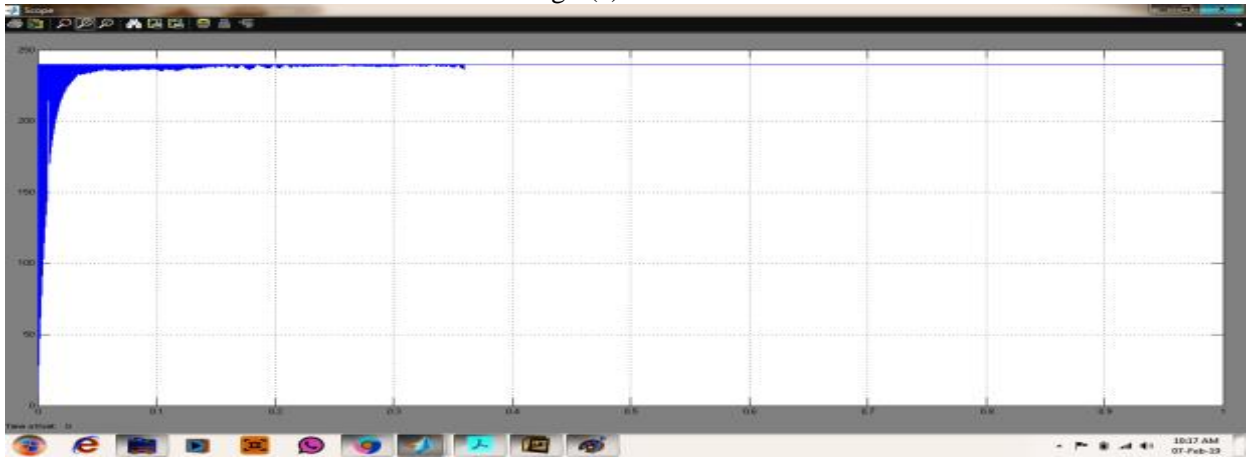

Fig.8(d)

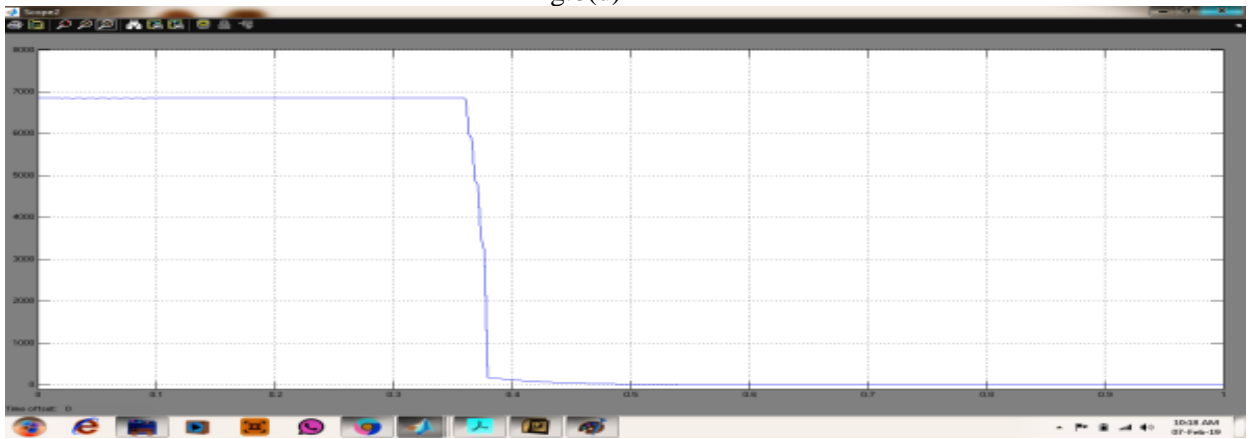

Fig.8(e)

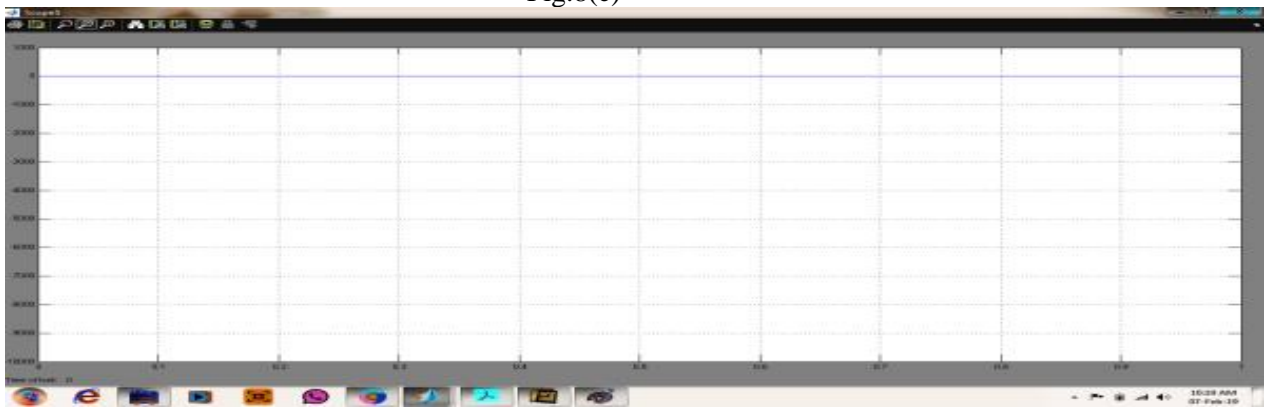

Fig.8(f)

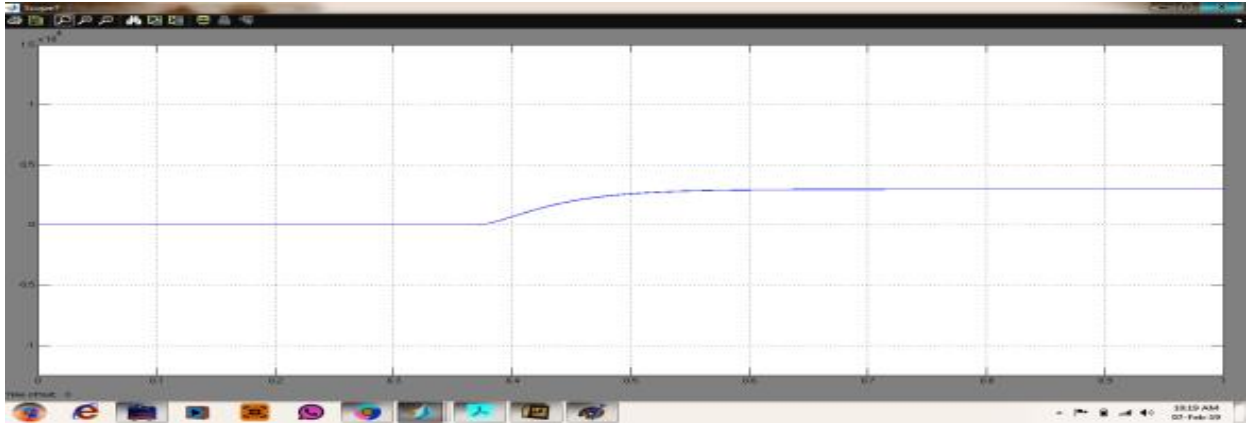

Fig.8(g)

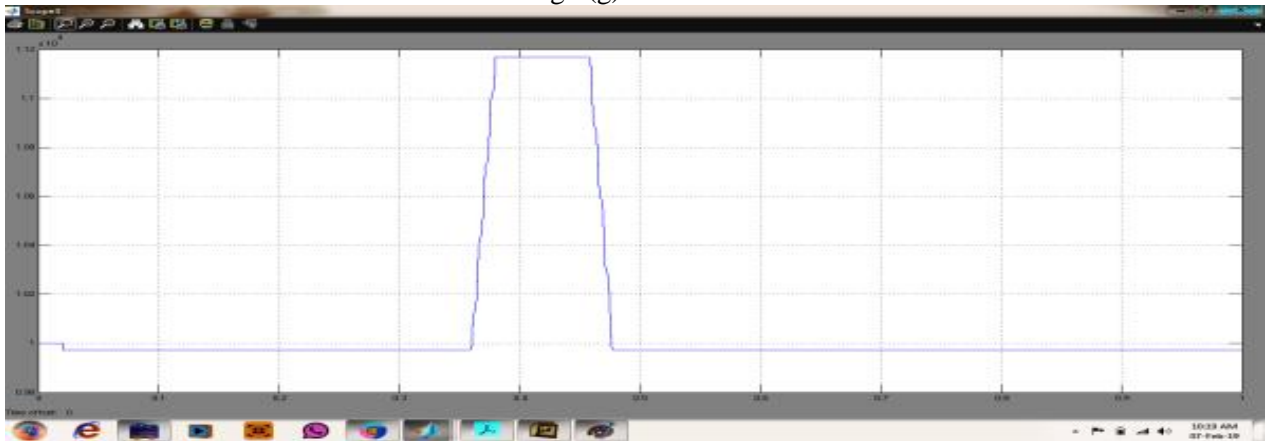

Fig.8(h)

Fig.8. External supply of battery

Fig.9 shows the situation when there are no delivering sources dealing with to the framework got together with low battery. Outside charging is required to continue the store need. Charging circuit is engaged by the reason condition. At  $t=0.4$  s, wind age is expelled from organization and because of lower battery voltage, the charging circuit is begun. In this manner external weight is mixed through the RSC to supply give load need anyway charging the batteries.

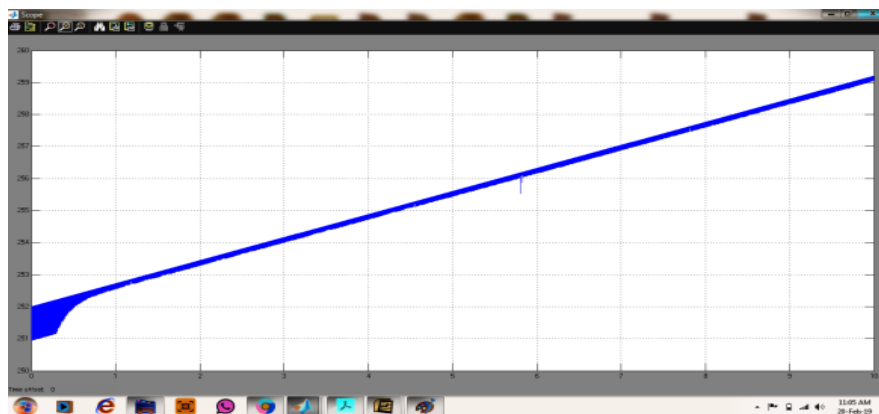

Fig.9(a)

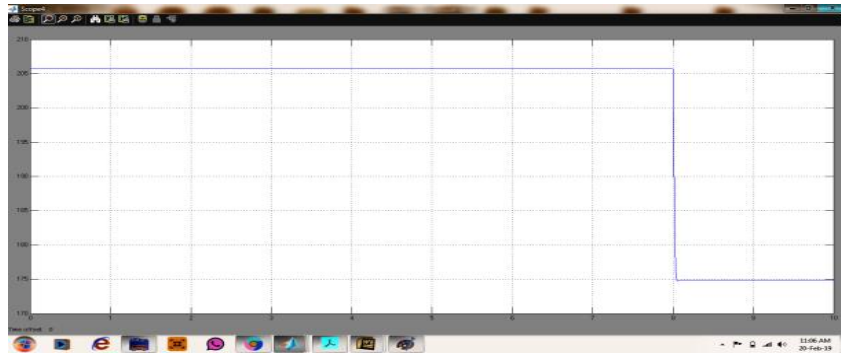

Fig.9(b)

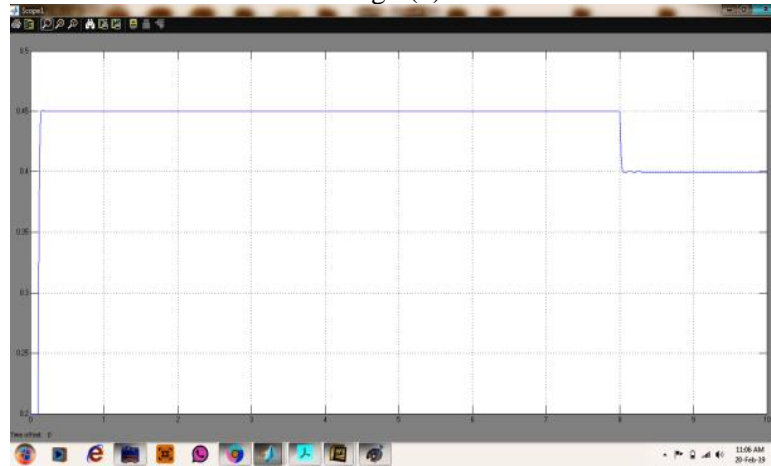

Fig.9(c)

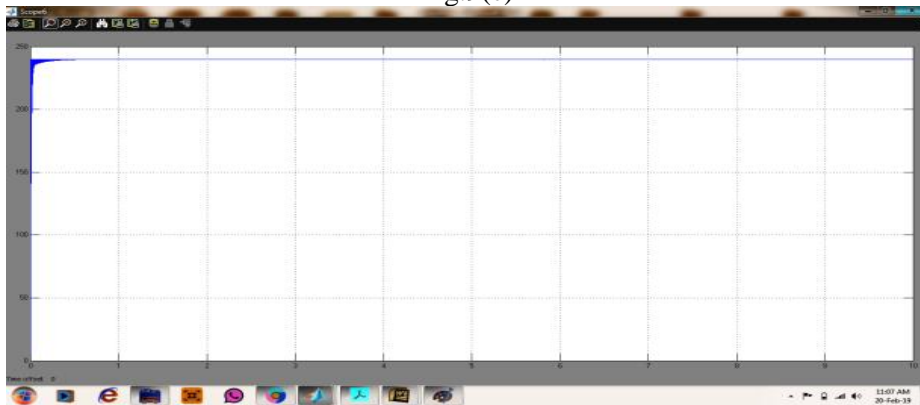

Fig. 9(d)

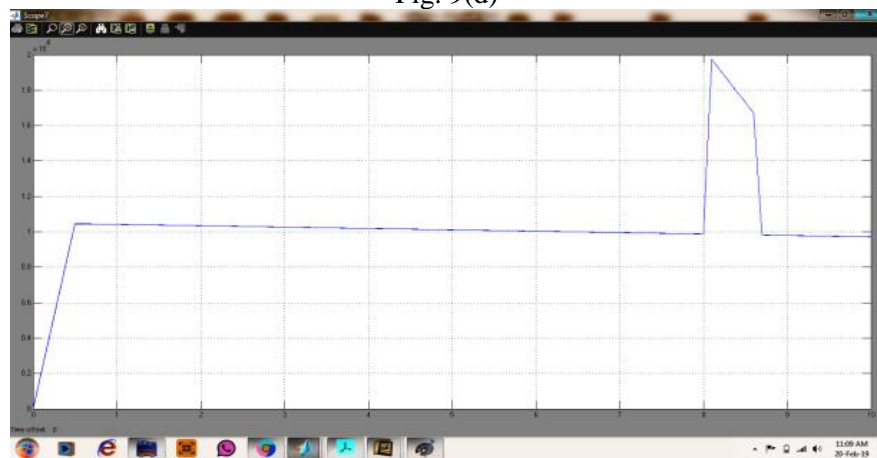

Fig. 9(e)

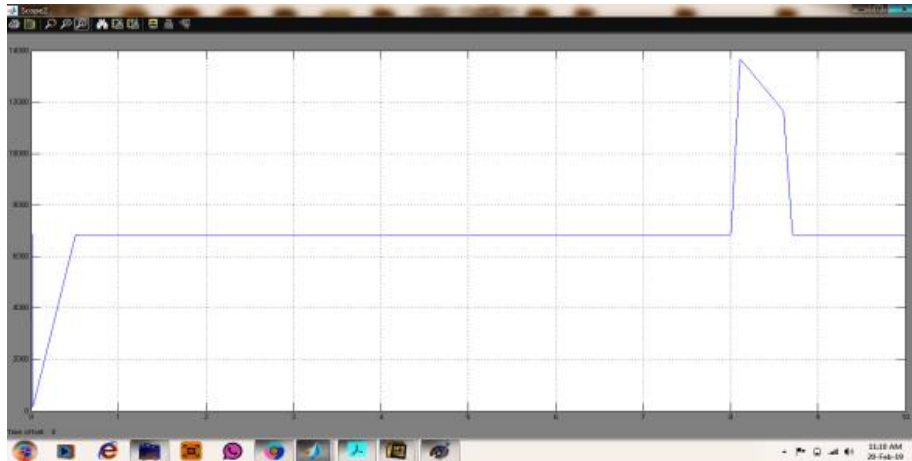

Fig. 9(f)

## CONCLUSION

The approached microgrid framework took care of from REGS have discovered appropriate about to meet the load prerequisite by distant separated area involving barely any domestic applications. The proposed REGS includes wind along with solar based vitality branches, it can be intended to remove that greatest power against sustainable power sources and simultaneously, it gives quality capacity to the shoppers. The framework has been intended for complete mechanized activity. In this work also search best seizing components. The presentation of the framework has been introduced for change in input conditions for various kinds of burden profiles. In all cases, quality of power is at the load is abide in adequate within the range. The adequacy of the framework is additionally given test results with model in the research facility. The framework has likewise imagined the outside battery charging about to using the RSC along it sense the accomplishing rectifier activity at solidarity power factor of the system.

## REFERENCES

1. H. Zhu, D. Zhang, H. S. Athab, B. Wu and Y. Gu, "PV Isolated Three- Port Converter and Energy-Balancing Control Method for PV-Battery Power Supply Applications," IEEE Transactions on Industrial Electronics, vol. 62, no. 6, pp. 3595-3606, June 2015.
2. M. Das and V. Agarwal, "Novel High-Performance Stand-Alone Solar PV System With High-Gain High-Efficiency DC-DC Converter Power Stages," IEEE Transactions on Industry Applications, vol. 51, no. 6, pp. 4718-4728, Nov.-Dec. 2015.
3. B. Ataji, Y. Miura, T. Ise and H. Tanaka, "Direct Voltage Control With Slip Angle Estimation to Extend the Range of Supported Asymmetric Loads for Stand-Alone DFIG," IEEE Transactions on Power Electronics, vol. 31, no. 2, pp. 1015-1025, Feb. 2016.
4. N.A. Orlando, M. Liserre, R.A. Mastromauro and A. Dell'Aquila, "A survey of control issues in PMSG-based small wind turbine system," IEEE Trans. Industrial Informatics, vol.9, no.3, pp 1211-1221, July 2013.
5. T. Hirose and H. Matsuo, "Standalone Hybrid Wind-Solar Power Generation System Applying Dump Power Control Without Dump Load," IEEE Trans. Industrial Electronics, vol. 59, no. 2, pp. 988-997, Feb. 2012.
6. Z. Qi, "Coordinated Control for Independent Wind-Solar Hybrid Power System," 2012 Asia-Pacific Power and Energy Engineering Conference, Shanghai, 2012, pp. 1-4.
7. M. Rezkallah, S. Sharma, A. Chandra and B. Singh, "Implementation and control of small-scale hybrid standalone power generation system employing wind and solar energy," 2016 IEEE Industry Applications Society Annual Meeting, Portland, OR, 2016, pp. 1-7.
8. Hamadi, S. Rahmani, K. Addoweesh and K. Al-Haddad, "A modeling and control of DFIG wind and PV solar energy source generation feeding four wire isolated load," IECON 2013 - 39th Annual Conference of the IEEE Industrial Electronics Society, Vienna, 2013, pp. 7778-7783.



9. S. K. Tiwari, B. Singh and P. K. Goel, "Design and control of autonomous wind-solar energy system with DFIG feeding 3-phase 4-wire network," 2015 Annual IEEE India Conference (INDICON), New Delhi, 2015, pp. 1-6.
10. S. K. Tiwari, B. Singh and P. K. Goel, "Design and control of micro-grid fed by renewable energy generating sources," 2016 IEEE 6th Inter. Conference on Power Systems (ICPS), New Delhi, 2016, pp. 1-6.
11. H. Polinder, F. F. A. van der Pijl, G. J. de Vilder and P. Tavner, "Comparison of direct-drive and geared generator concepts for wind turbines," IEEE International Conference on Electric Machines and Drives, 2005., San Antonio, TX, 2005, pp. 543-550.
12. Emmanouil A. Bakirtzis and Charis Demoulias "Control of a micro-grid supplied by renewable energy sources and storage batteries," XXth Inter. Conf. on Electrical Machines (ICEM), pp. 2053-2059, 2-5 Sept. 2012.
13. S. Heier, Grid Integration of Wind Energy Conversion Systems. Hoboken, NJ: Wiley, 1998.
14. Z.M. Salameh, M.A. Casacca and W.A. Lynch, "A mathematical model for lead-acid batteries," IEEE Trans. Energy Convers., vol. 7, no. 1, pp. 93-97, Mar. 1992.
15. A. B. Rey-Boué, R. García-Valverde, F. de A. Ruz-Vila and José M. Torreló-Ponce, "An integrative approach to the design methodology for 3-phase power conditioners in Photovoltaic Grid-Connected systems," Energy Conversion and Management, vol. 56, pp. 80–95, Dec 2011.
16. Z. Xuesong, Song Daichun, Ma Youjie and Cheng Deshu, "The simulation and design for MPPT of PV system based on incremental conductance method," 2010 WASE Inter. Conf. on Information Engineering, Aug, 2010, pp. 314–317.